

10113 PLAN

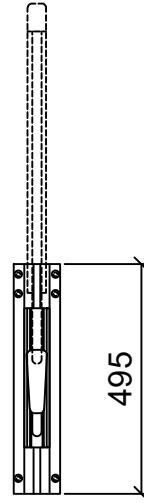

10113 FRONT

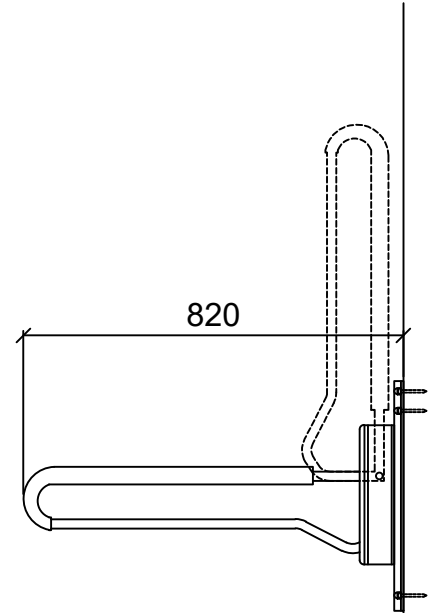

10113 SIDE