

10116 PLAN

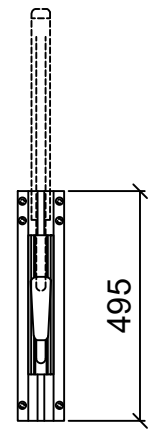

10116 FRONT

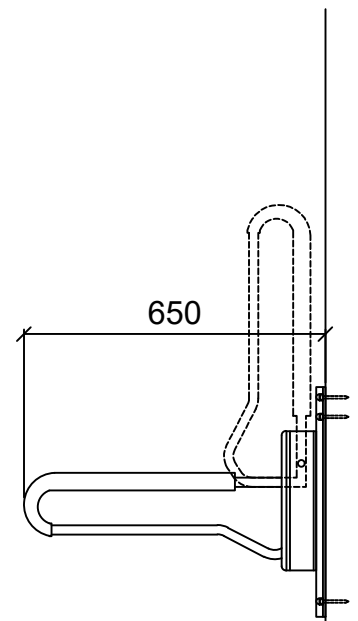

10116 SIDE