

10125 PLAN

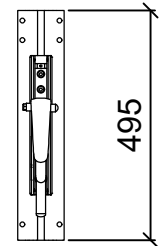

10125 FRONT

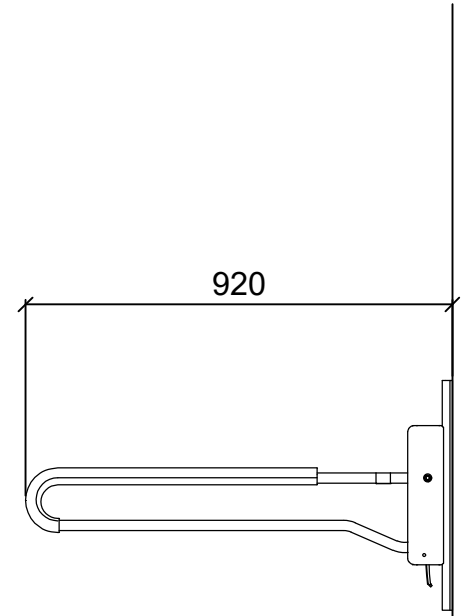

10125 SIDE