

20108 PLAN

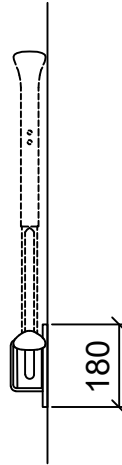

20108 FRONT

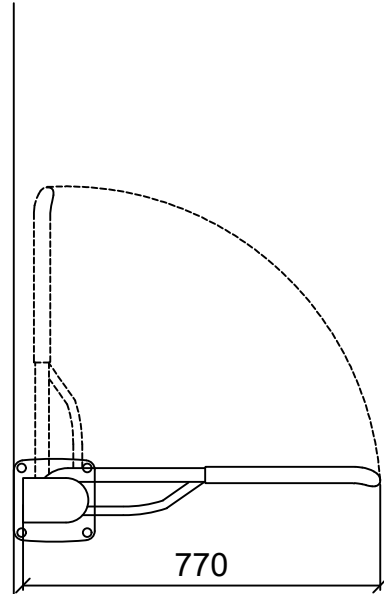

20108 SIDE