

20111 PLAN

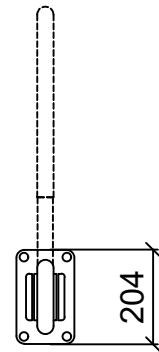

20111 FRONT

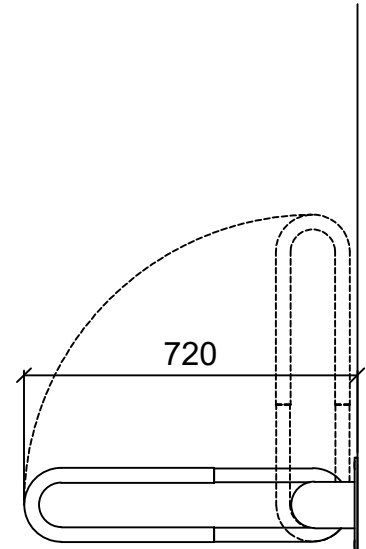

20111 SIDE