

20209 PLAN

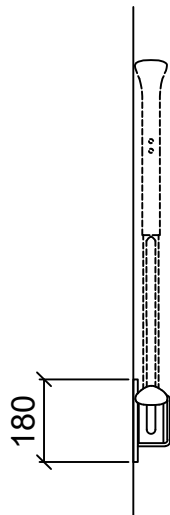

20209 FRONT

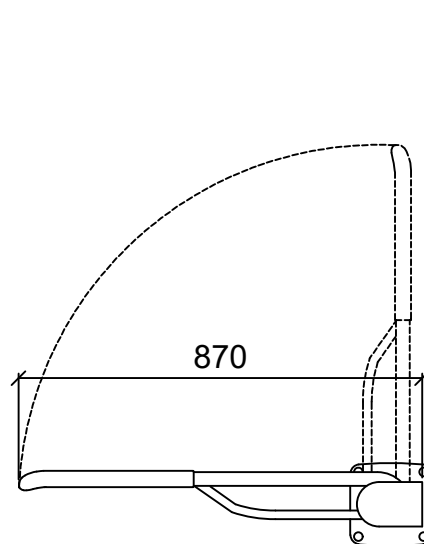

20209 SIDE