

20210 PLAN

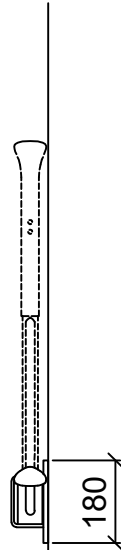

20210 FRONT

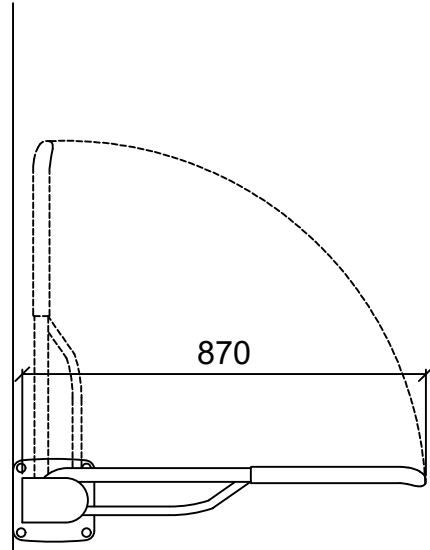

20210 SIDE